

FR 5735

SLIDE TYPE:	Pocket Door Ball Bearing Slide System
MOUNTING:	Side Mount

WIDTH:	11.4 mm (0.45 in.)
LOAD CAPACITY:	dynamic up to 45 kg (100 lbs.)

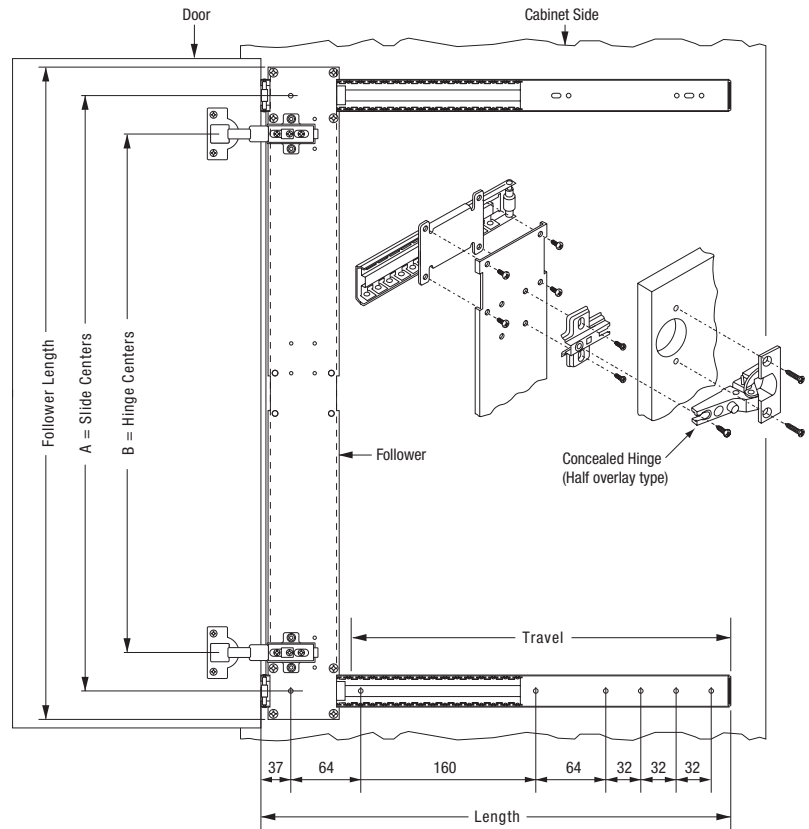
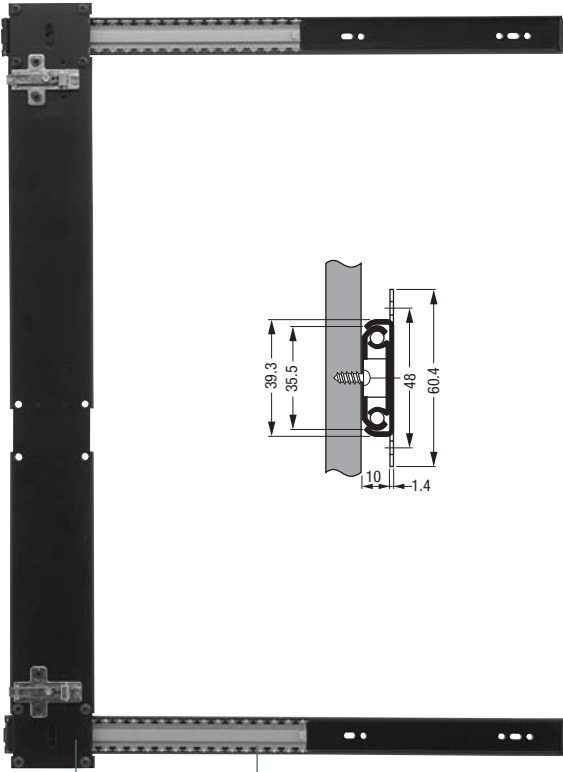

MATERIAL: cold rolled steel

FEATURES: steel ball bearings

- SPECIFICATIONS:**
- ▶ A very smooth running slide system with 6 ball bearings per inch length of the retainer.
 - ▶ Follower is made of 2 mm thick steel and is very rigid without deflection
 - ▶ Any hinge manufactures hinges and base plates will fit and are attached with sheet metal screws to the follower
 - ▶ We recommend 3 slides for extra heavy doors and above 32 in. in height
 - ▶ Custom sizes on request
 - ▶ As an option a wooden follower can also be used
 - ▶ Set packing: 2 or 3 slides, 1 Follower, 1 Guide roller, 1 screw bag and hinges on request

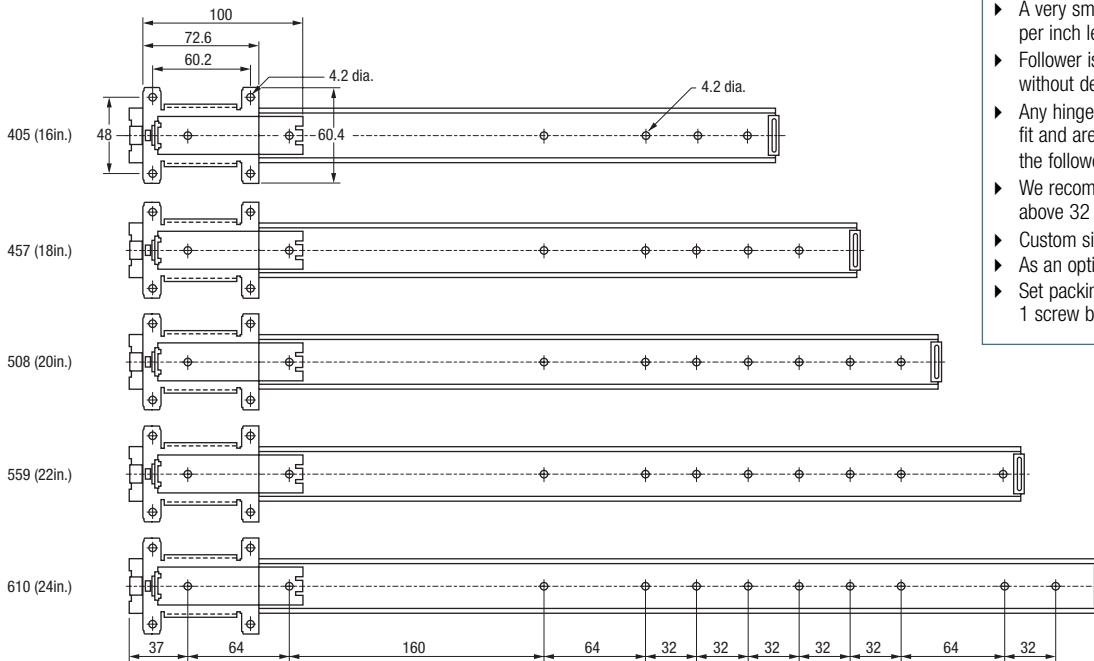

Length	Travel		Weight	Order No.
	mm	in		
405	16.00	300 12.00	*	400050
457	18.00	350 14.00	*	400051
508	20.00	400 16.00	*	400052
559	22.00	450 18.00	*	400053
610	24.00	500 20.00	*	400054

Packing Unit: 20 pair per box * on request

FR 5735

SLIDE TYPE:	Pocket Door Ball Bearing Slide System
MOUNTING:	Side Mount

WIDTH:	11.4 mm (0.45 in.)
LOAD CAPACITY:	dynamic up to 45 kg (100 lbs.)

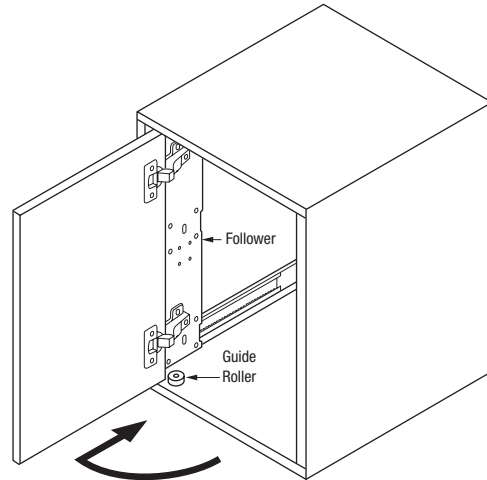
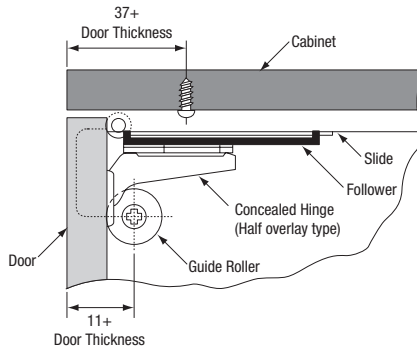

Description:	Material	Color	Notes	Order No.
Guide Roller				
FR 5735.R.	Nylon	white	Requires a 5 mm dia. hole	400066
Packing Unit: per piece				

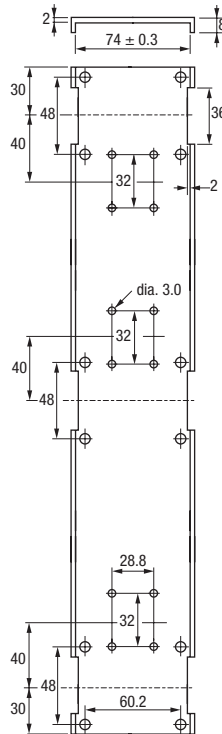

Description:	Length		Slide Centers		Hinge Centers		Weight		Order No.
	mm	in	mm	in	mm	in	kg	lbs	
FR 5750.F.	500	19.70	440	17.30	360	14.20	*		400060
FR 5765.F.	650	25.60	590	23.20	510	20.10	*		400061
FR 5780.F.	800	31.50	740	29.10	660	26.00	*		400062
FR 5795.F.	950	37.40	890	35.00	810	31.90	*		400063
FR 5711.F.	1100	43.00	1040	40.90	960	37.80	*		400064
Packing Unit: 20 pieces per box including screws									* on request